

CRANES  
and  
TOOLS

**VICARIO**

Gru idraulica  
di qualità  
100% Italiana

**OMV 30A**

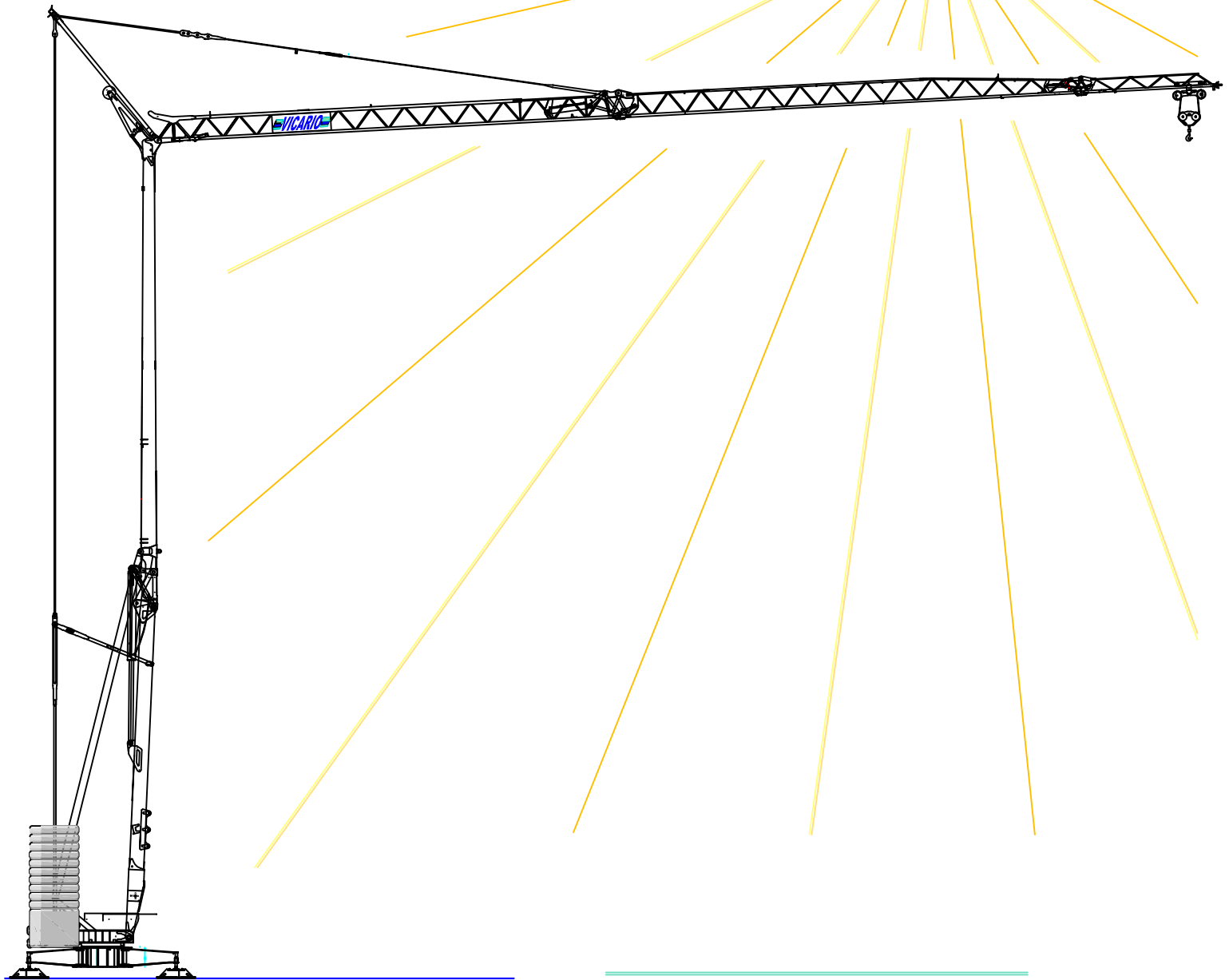

una novità delle Officine Meccaniche

Ein neuer VICARIO Kran

A new crane from VICARIO Industries

Une nouvelle grue de VICARIO

Una nueva grua de VICARIO

**VICARIO**

# OMV 30A

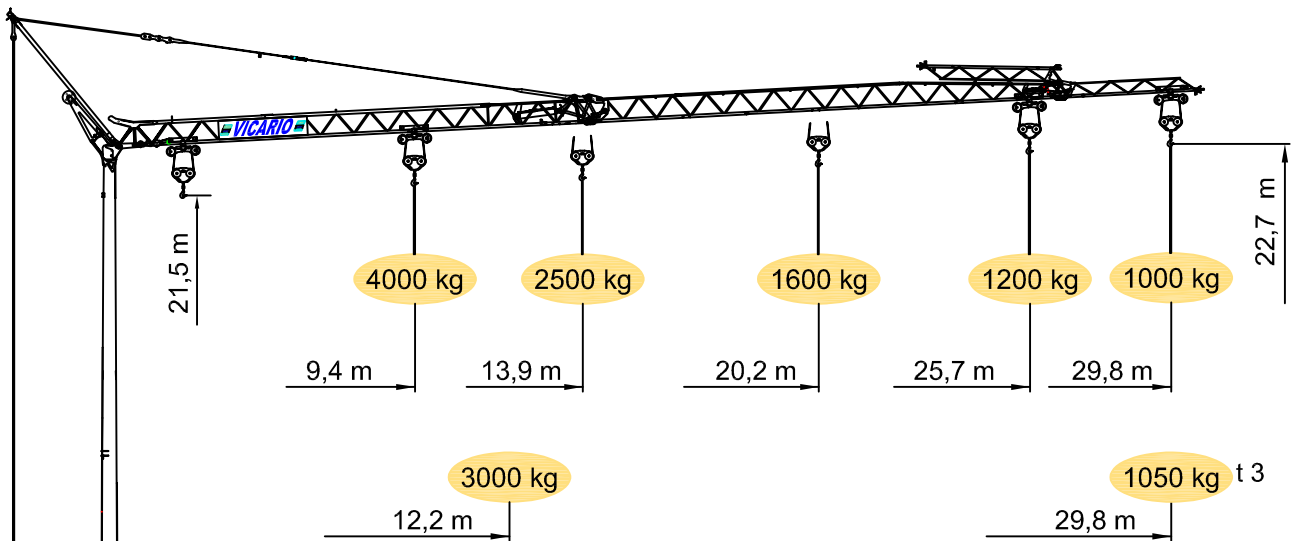
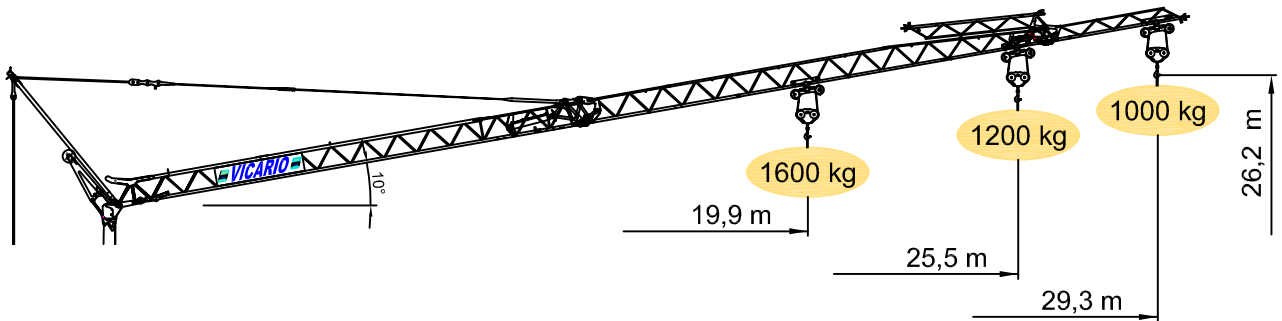
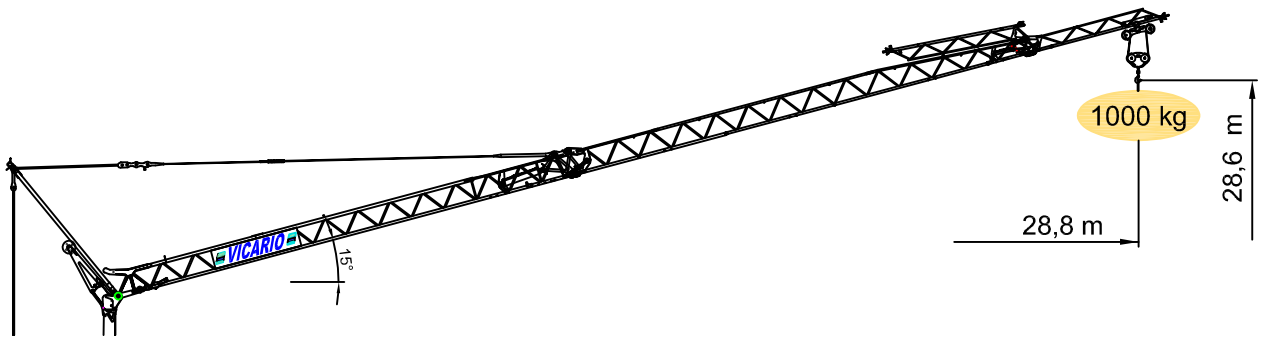

m	9,6	12	14	16	18	20	22	24	26	28	29,8
kg	4000	3030	2514	2140	1857	1635	1456	1309	1186	1081	1000



m	12,2	14	16	18	20	22	24	26	28	29,8
kg	3000	2557	2184	1902	1681	1503	1357	1235	1131	1050

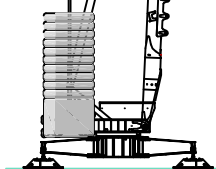

## DOTAZIONE DI SERIE

Sollevamento "overdrive" a quattro velocità con inverter, rotazione e carrello a tre velocità con inverter, zincatura della struttura e dei tiranti, contrappeso, braccio impennabile, carrello rampante con motore e finecorsa alla base della torre, funzionamento con braccio ripiegato, comando a pulsantiera via cavo, carter di protezione per ralla e meccanismi, predisposizione per autozavorramento e radiocomando, armadio elettrico in acciaio inox, documentazione a norme CEE.

## STANDARD FEATURES

4-speed lifting, 3-speed rotation and trolley with inverter control, galvanised structure, counterweight, pull-up jib, translation trolley with motor and limit switch at base of gantry, operation with folden jib, cable-operated pushbutton remote control, guard for slewing ring and mechanisms, designed to allow installation of self-ballasting device and radio control, stainless steel electrical cabinet, documentation in accordance with EU standards.

## EQUIPEMENT DE SERIE





Levage à quatre vitesses, chariot et rotation à trois vitesses à contrôle électronique, galvanisation de la structure et des tirants, contrepoids, flèche relevable, moteur de chariot et fin de course à la base de la tour, fonctionnement bras replié, commande par câble, carter de protection pour la couronne et les mécanismes, predisposition pour autolestage et commande radio, armoire électrique en acier inox, documentation conforme aux normes CEE.

## SERIENAUSSTATTUNG

Heben mit vier Geschwindigkeiten, Laufkatze und Rotation mit drei Geschwindigkeiten, Strukturverzinkung, Gegengewicht, hochklappbarer Arm, aufsteigender Wagen mit Motor und Anschlag an der Basis des Turms, Funktionieren mit eingeklapptem Arm, Steuerung mit Druckknopftaste via Kabel, Schutzvorrichtungen für Drehverbindungen und Mechanismen, Vorbereitung für Selbstballasteinbaue und Funksteuerung, elektrischer Schrank aus rostfreiem Stahl, Dokumentation gemäß EC Vorschriften.

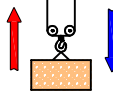
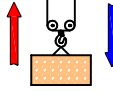
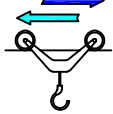
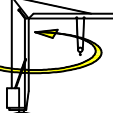
## DOTACION DE SERIE

Levantamiento a cuatro velocidades, carro y rotación a tres velocidades con control electrónico, galvanización de la estructura, contrapeso, brazo empuñable, carro rampante con motor y fin de carrera en la base de la torre, funcionamiento con brazo replgado, funcionamiento por pulsadores via cable, carter de protección para corona de giro y mecanismos, predisposición para autocontrapeso y radioccontrol, armario eléctrico de acero inox, documentación según normas CEE.

	400V (±10%) 50 Hz		12* - 18kVA			
	m/l'	▶	▶▶	▶▶▶	▶▶▶▶	
	kg	6	20	42	50	
kW	3000	3000	1000	1000	11* (Inverter)	
	m/l'	▶	▶▶	▶▶▶	▶▶▶▶	
	kg	6,3	21	31	48	
kW	4000	4000	1400	1400	15 (Inverter)	
	m/l'	▶	▶▶	▶▶▶		
	kg	17.8	28.6	53.5 (↗39.3)		
kW	3 (Inverter)					
	n/l'	▶	▶▶	▶▶▶		
	kg	0.15	0.42	0.84		
kW	1.55 (Inverter)					
	min	▶				
	kW	12				
	13.150 kg		5.200 kg + 13.000 kg			
	7800 kg	5200 kg	2600 kg	0 kg		
P1	8682 kg 9507 kg *	6670 kg 7456 kg *	4648 kg 5395 kg *	2530 kg 3245 kg *		
P2	12258 kg 11433 kg *	11680 kg 10894 kg *	11102 kg 10355 kg *	10620 kg 9905g *		

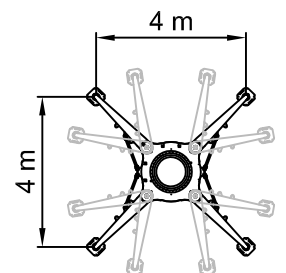
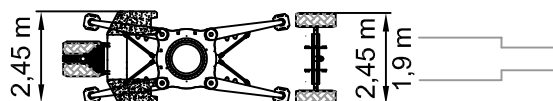
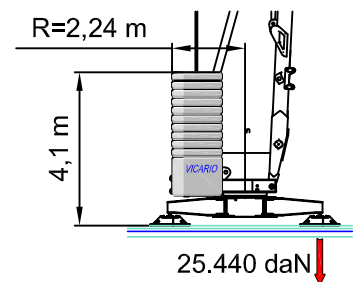
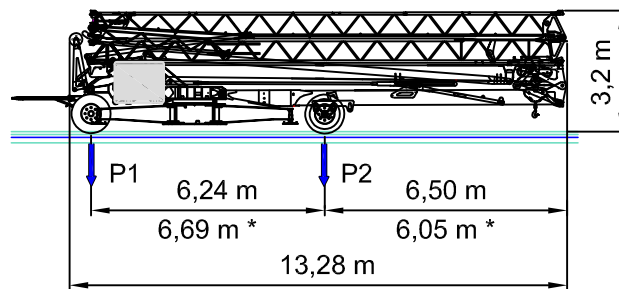

360°

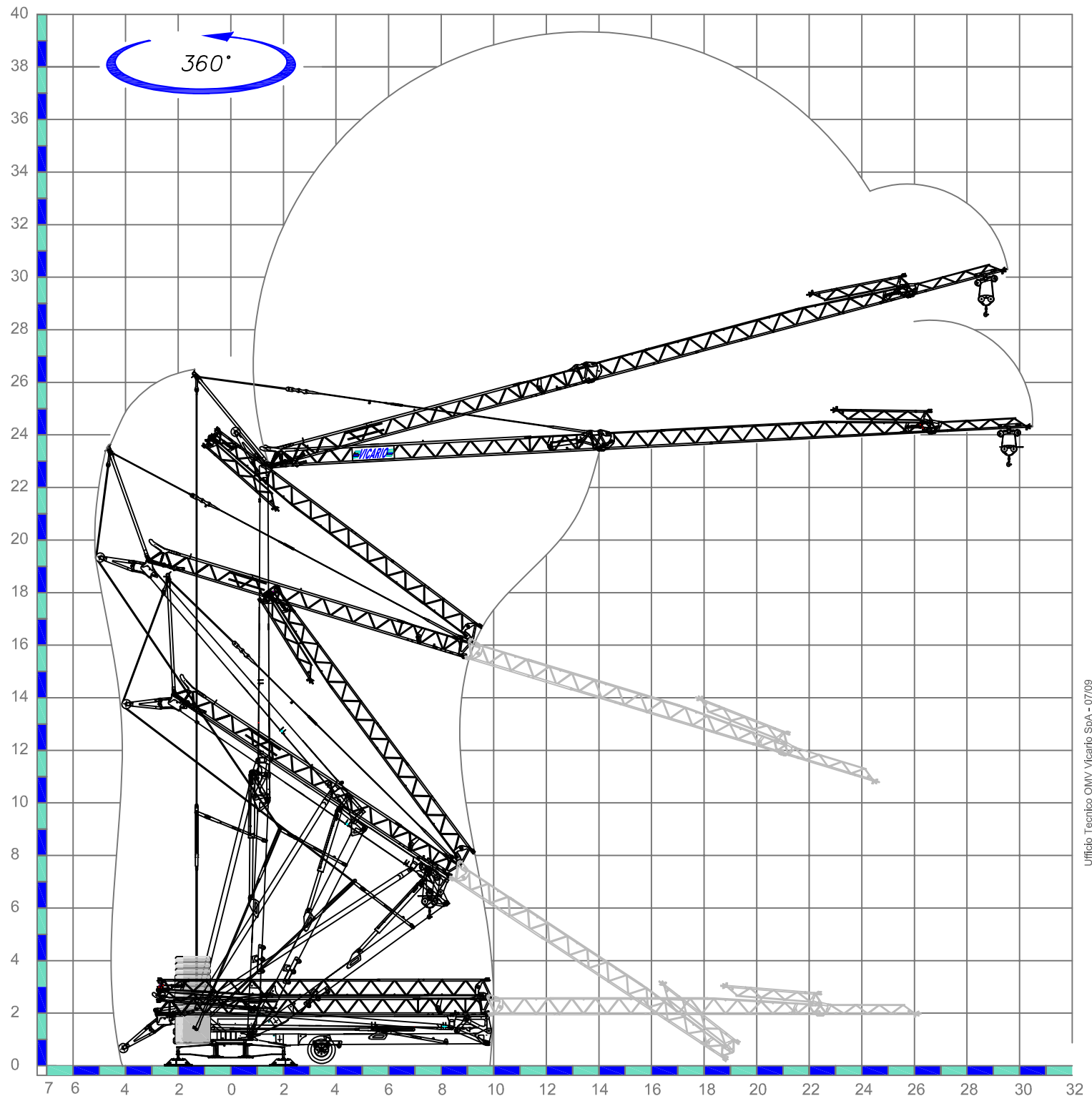

Ufficio Tecnico OMV Vicario SpA - 07/09

Sequenza di montaggio su 360°. Aufstellvorgang über 360°. Déroulement de montage sur 360°. Erection procedure on 360°. Montaje sobre 360°.

CRANES  
and  
TOOLS **VICARIO**  
**Officine Meccaniche Vicario S.p.a.**

Via Piola, 4

28013 Gattico - Veruno (NO) ITALIA

Tel. 0322 846690 Fax 0322 860009

Internet: [www.vicariogru.com](http://www.vicariogru.com) E-Mail: [omv@vicariogru.com](mailto:omv@vicariogru.com)

Agente di zona: